

# flexiguide

## Product Specification

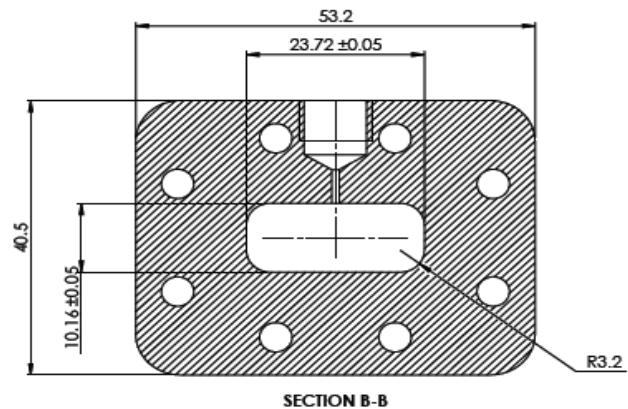
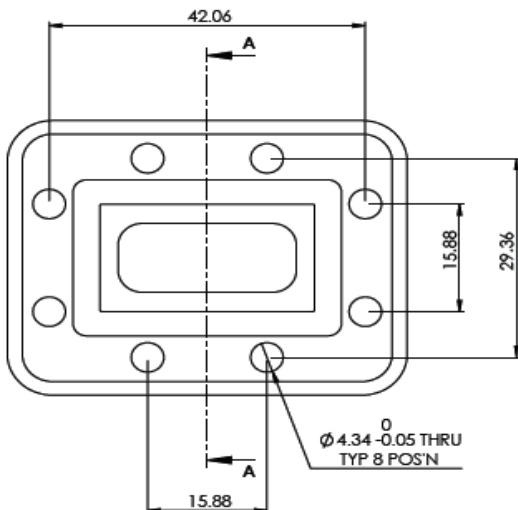

### Part Number:

**PI16C-P-\*-FK**

\* = see options below

### Description

Product Type:  
Waveguide Size:  
Flange Type:  
Flange Material / Plating:  
\* Paint Finish:  
Accessories:

Pressure Inlet  
WG16 / WR90 / R100  
16C (CPR90G)  
Aluminium / Passivation  
G = Gray (RAL 7012), B = Black, W = White  
Screws, Nuts, Washers, O-Ring(s) / Gasket(s)

### Mechanical Specifications

Thread Size:  
Thickness:  
Gasket Groove Depth:

1/8" BSP (Parallel) - not compatible with NPT/NPS  
16 mm / 0.6 inches  
1.02 mm / 0.04 inches

### Electrical Specifications

Frequency Range: 8.20 - 12.4 GHz  
Insertion Loss: 0.05 dB  
Return Loss: 34.2 dB

### Environmental Performance

Temperature Range: -70 to +150°C  
ETSI Class: ETSI EN 300-019-2-4 Class 4.1  
I.P. Rating: IP65 (Weatherproof)